

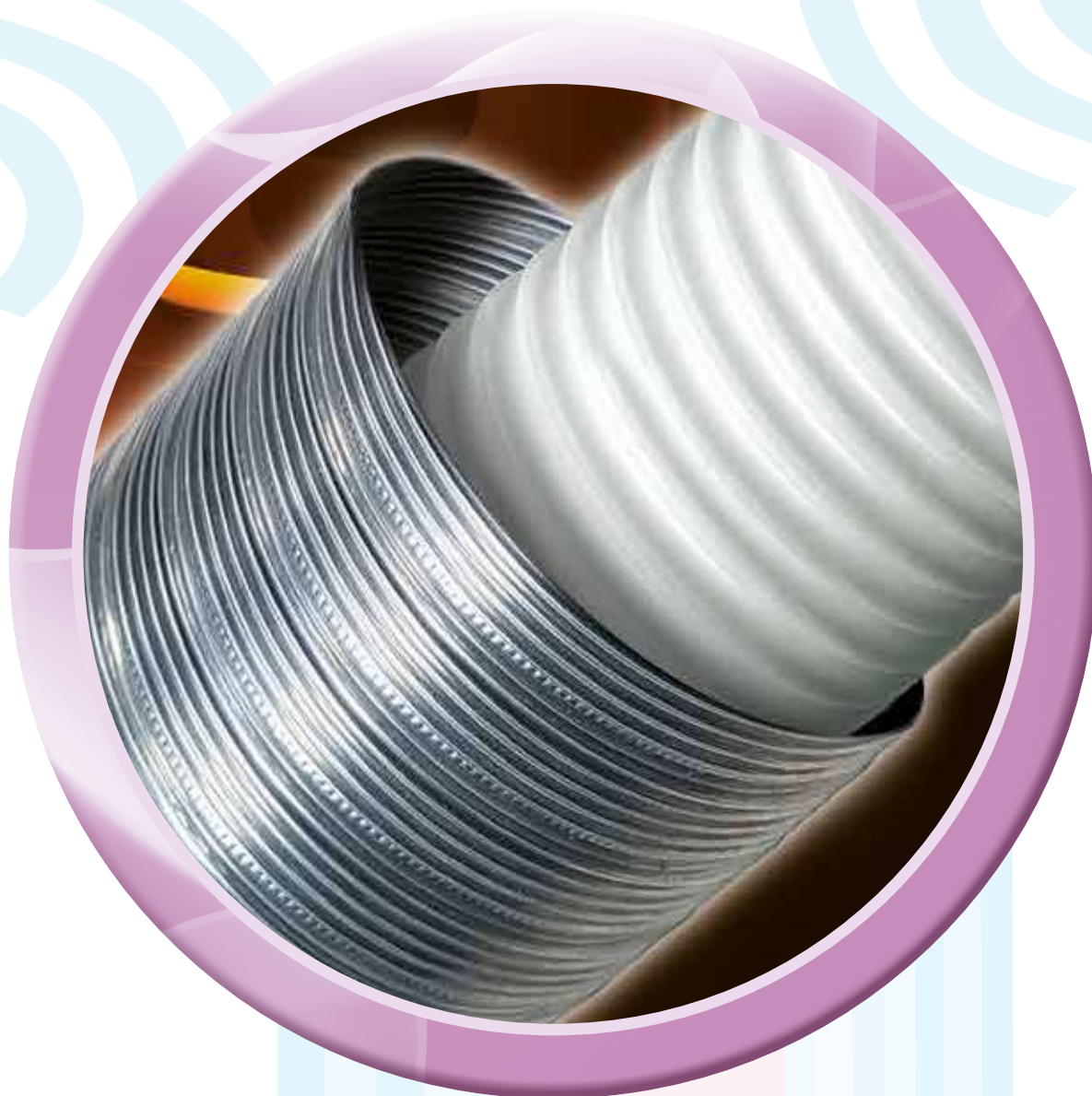

TERMOCOM

S i s t e m i s c a r i c o f u m i













FLESSIBILE COASSIALE PPs - INOX
FLEXIBLE LINER PPs - INOX COAXIAL

Serie AIRFLEX

Serie AIRFLEX

A RICHIESTA
ON REQUEST

Serie AIRFLEX

	Øi	Ø 60	Ø 80
	Øe	Ø 100	Ø 125
 Terminale per scarico fumi PP nero / PP terminal for smoke exhaust black color	COD.	NEXPLSCAFUM060	NEXPLSCAFUM080
 Kit guarnizione e fascetta Kit seal and locking band	COD.	EXPLGF060	EXPLGF080
 Piastra di tenuta Flex top plate	COD.	233PIAFLEX100	233PIAFLEX125
 Collare di bloccaggio per piastra di tenuta / Top clamp for flexible pipe	COD.	234CBFLEX100	234CBFLEX125
 Collare di centraggio Spacing bracket	COD.	347CD100	347CD125
 Collare a muro Wall bracket	COD.	360COLLSS100	360COLLSS125
 AirFLEX rotolo standard / standard coil	LUNGH.	m 9 •	m 9 •
 AirFLEX metro lineare / linear meter	COD.	AIRFLEX060	AIRFLEX080
 Giunto flex inox rigido maschio / Flexadapter to rigid male	COD.	240ALIS100	240ALIS125
 T a 90° / 90° tee	COD.	CA15060	CA15080
 Scarico condensa Tee cap with condense drain	COD.	CA24060	CA24080

- POSSIBILI RICHIESTE DI ROTOLI COMPOSTI DA METRI DIVERSI
POSSIBLE REQUESTS FOR ROLLS CONSISTING OF DIFFERENT METERS

KIT COASSIALI PER TUTTI I TIPI DI CALDAIA.

Per la scelta del kit in base alla caldaia, consulta il listino prezzi.

COAXIAL KITS FOR ALL TYPES OF BOILERS.

To choose the kit based on the boiler, see price list.

Flessibile coassiale PPs - inox
Flexible liner PPs - inox coaxial



Kit raccordo flex femmina
Female flex kit connector

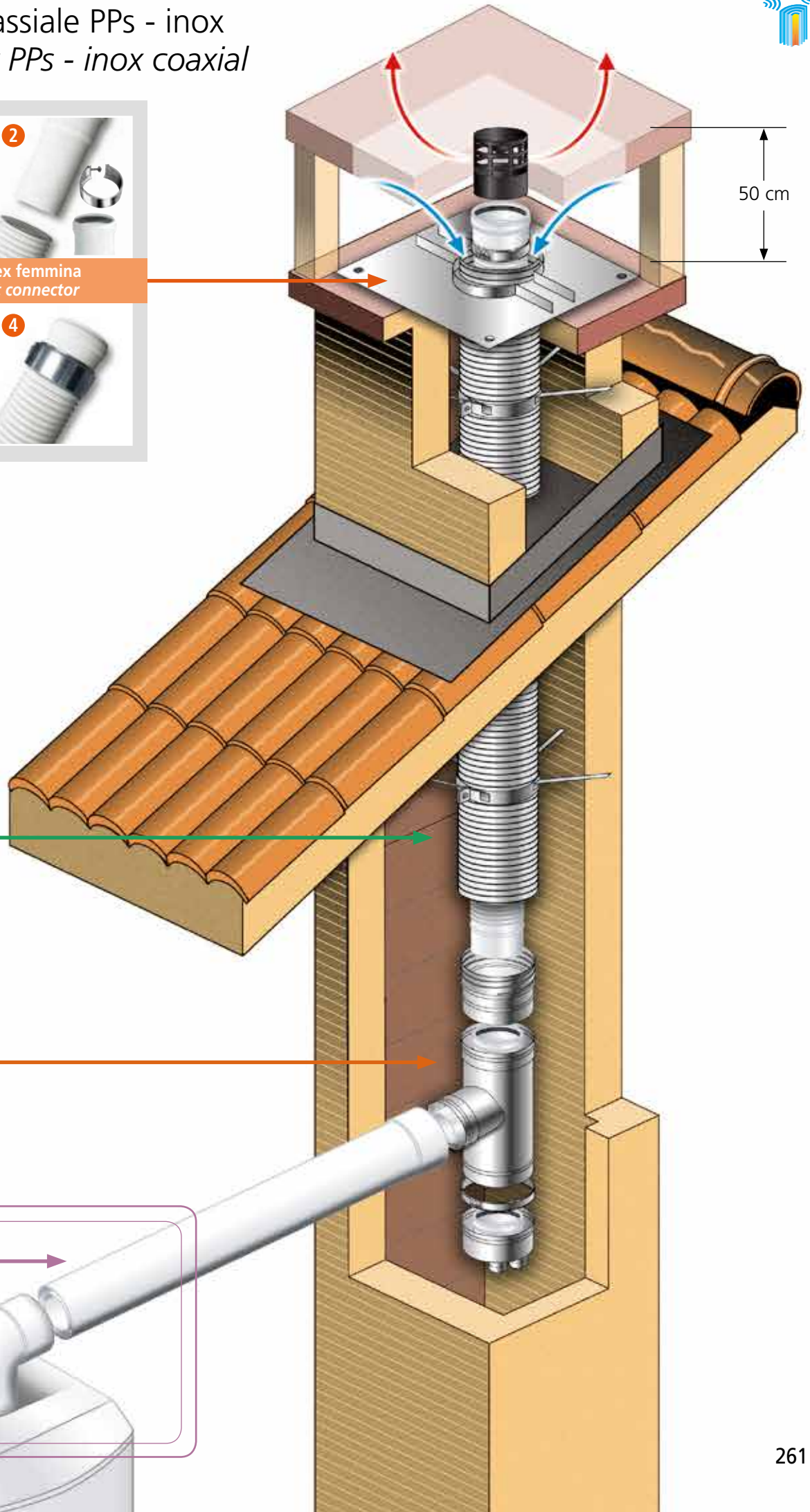

AirFLEX

CAVEDIO

KitCOAX

Serie AIRFLEX

Serie AIRFLEX

Flessibile coassiale PPs - inox
Flexible liner PPs - inox coaxial

Ø 60/100 - Ø 80/125

Serie AIRFLEX



DESIGNAZIONE:

T120 P1 W 2 000 LE E UO